

Bellows Suction Cups SPB1 (1.5 Folds)

Suction area (Ø) from 10 mm to 80 mm

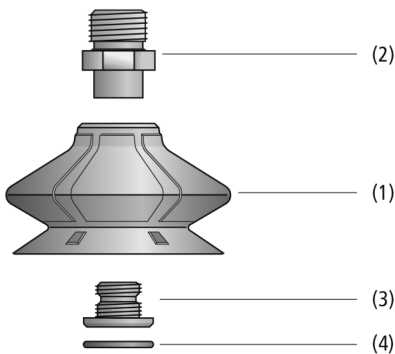

Bellows Suction Cups SPB1 (1.5 Folds)



System design Bellows Suction Cups SPB1 (1.5 Folds)

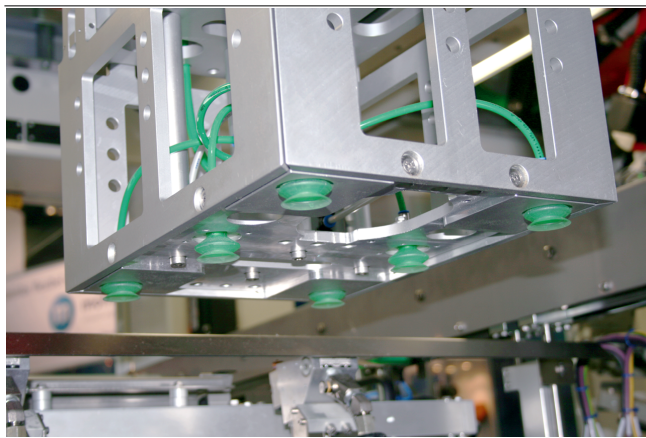

Bellows suction cups SPB1 being used for handling of cardboard

Suitability for industry specific applications

Application

- Round bellows suction cup with 1.5 folds for the use in cardboard box and tray erectors
- Handling of cardboards and rigid packaging in top-loading and side-loading machines
- Palletizing and depalletizing processes
- Heavy-duty applications that require suction cups with excellent sealing and low wear

Design

- Round bellows suction cup SPB1 (1) with 1.5 folds and soft, flexible sealing lip
- Made of wear-proof material Elastodur ED-65
- Models with diameter up to 30 mm feature plug-in connection element
- Starting at 40 mm diameter with a two-piece connection element: consisting of machine-side component (2) and suction-side component (3)
- Clip-in filter screen (4) as pre-filter
- All connection elements with male thread are equipped with integrated sealing on the fastening thread

Product highlights

- Suction cup seals optimally on cardboard boxes and rigid packaging
- High intrinsic stability of the suction cup in dynamic processes
- Spacing elements between sealing lip and fold prevent the suction cup from moving
- High suction force with small dimensions thanks to large effective suction area
- Material Elastodur ED-65 minimizes wear (service life approx. 3 times higher than with NBR)

Bellows Suction Cups SPB1 (1.5 Folds)

Suction area (Ø) from 10 mm to 80 mm

Designation code Bellows Suction Cups SPB1 (1.5 Folds)

SPB1	-	30	-	ED-65	-	G1/8-AG
1		2		3		4

1 – Abbreviated designation

Code	Version
SPB1	1.5 folds

2 – Suction area

Code	Diameter in mm
10...80	ø 10 to 80

3 – Material

Code	Material
ED-65	Elastodur

4 – Connection

Code	Connection
M5-AG	M5-AG (AG = male (M))
M5-IG	M5-IG (IG = female (F))
G1/8-AG	G1/8-AG
G1/8-IG	G1/8-IG
G1/4-AG	G1/4-AG
G1/4-IG	G1/4-IG
G3/8	G3/8
G1/2	G1/2



















Suction cup SPB1 (elastomer part + connection element) is delivered assembled. The assembly consists of:

- Suction cup of type SPB1 – elastomer part, available in various diameters
- Connection element of type SC – available with various threads

Available spare parts: suction cup SPB1, connection element (Schmalz-Connector)

Available accessories: filter screen (sieve, round), suction cup insert

Ordering data Bellows Suction Cups SPB1 (1.5 Folds)

Type	Vacuum connection:					
	M5-M	M5-F	G1/8"-M	G1/8"-F	G1/4"-M	G1/4"-F
SPB1 10	10.01.06.03489 	10.01.06.03568 	-	-	-	-
SPB1 15	-	-	10.01.06.03490 	10.01.06.03491 	-	-
SPB1 20	-	-	10.01.06.03492 	10.01.06.03493 	-	-
SPB1 25	-	-	10.01.06.03494 	10.01.06.03495 	-	-
SPB1 30	-	-	10.01.06.03496 	10.01.06.03497 	10.01.06.04530	-
SPB1 40	-	-	-	-	10.01.06.03498 	10.01.06.03499 
SPB1 50	-	-	-	-	10.01.06.03500 	10.01.06.03501 
SPB1 60	-	-	-	-	10.01.06.03502 	10.01.06.03503 
SPB1 80	-	-	-	-	10.01.06.03504 	10.01.06.03505 

Type	Vacuum connection:			
	G3/8-AG	G3/8-IG	G1/2-AG	G1/2-IG
SPB1 80	10.01.06.03911	10.01.06.03910	10.01.06.03919	10.01.06.03918

Bellows Suction Cups SPB1 (1.5 Folds)

Suction area (Ø) from 10 mm to 80 mm

Ordering data Spare parts Bellows Suction Cups SPB1 (1.5 Folds)

Type*	Spare parts			Part no.
SPB1 10	Bellows suction cup (round)	SPB1 10 ED-65 SC030		10.01.06.02782
SPB1 15	Bellows suction cup (round)	SPB1 15 ED-65 SC040		10.01.06.02783
SPB1 20	Bellows suction cup (round)	SPB1 20 ED-65 SC040		10.01.06.02452
SPB1 25	Bellows suction cup (round)	SPB1 25 ED-65 SC040		10.01.06.02453
SPB1 30	Bellows suction cup (round)	SPB1 30 ED-65 SC040		10.01.06.02454
SPB1 40	Bellows suction cup (round)	SPB1 40 ED-65 SC050		10.01.06.02455
SPB1 50	Bellows suction cup (round)	SPB1 50 ED-65 SC050		10.01.06.02456
SPB1 60	Bellows suction cup (round)	SPB1 60 ED-65 SC050		10.01.06.02457
SPB1 80	Bellows suction cup (round)	SPB1 80 ED-65 SC065		10.01.06.03071

*Additional material specifications at beginning of the section "Vacuum Suction Cups"

Type*	Spare parts		Part no.
SPB1 10 ED-65 M5-AG	Schmalz-Connector	SC 030 M5-AG	10.01.06.02802
SPB1 10 ED-65 M5-IG	Schmalz-Connector	SC 030 M5-IG	10.01.06.03440
SPB1 15 ED-65 G1/8-AG	Schmalz-Connector	SC 040 G1/8-AG	10.01.06.02490
SPB1 15 ED-65 G1/8-IG	Schmalz-Connector	SC 040 G1/8-IG	10.01.06.02482
SPB1 20 ED-65 G1/8-AG	Schmalz-Connector	SC 040 G1/8-AG	10.01.06.02490
SPB1 20 ED-65 G1/8-IG	Schmalz-Connector	SC 040 G1/8-IG	10.01.06.02482
SPB1 25 ED-65 G1/8-AG	Schmalz-Connector	SC 040 G1/8-AG	10.01.06.02490
SPB1 25 ED-65 G1/8-IG	Schmalz-Connector	SC 040 G1/8-IG	10.01.06.02482
SPB1 30 ED-65 G1/8-AG	Schmalz-Connector	SC 040 G1/8-AG	10.01.06.02490
SPB1 30 ED-65 G1/8-IG	Schmalz-Connector	SC 040 G1/8-IG	10.01.06.02482
SPB1 40 ED-65 G1/4-AG	Schmalz-Connector	SC 050 G1/4-AG MOD	10.01.06.02487
SPB1 40 ED-65 G1/4-IG	Schmalz-Connector	SC 050 G1/4-IG MOD	10.01.06.02488
SPB1 50 ED-65 G1/4-AG	Schmalz-Connector	SC 050 G1/4-AG MOD	10.01.06.02487
SPB1 50 ED-65 G1/4-IG	Schmalz-Connector	SC 050 G1/4-IG MOD	10.01.06.02488
SPB1 60 ED-65 G1/4-AG	Schmalz-Connector	SC 050 G1/4-AG MOD	10.01.06.02487
SPB1 60 ED-65 G1/4-IG	Schmalz-Connector	SC 050 G1/4-IG MOD	10.01.06.02488
SPB1 80 ED-65 G1/4-AG	Schmalz-Connector	SC 065 G1/4-AG L MOD	10.01.06.03193
SPB1 80 ED-65 G1/4-IG	Schmalz-Connector	SC 065 G1/4-IG L MOD	10.01.06.03194

*Additional material specifications at beginning of the section "Vacuum Suction Cups"

Bellows Suction Cups SPB1 (1.5 Folds)

Suction area (\emptyset) from 10 mm to 80 mm

Ordering data Accessories Bellows Suction Cups SPB1 (1.5 Folds)

Type	Accessories			Part no.
SPB1	10	Cup insert PA	SPI 8 PA SPB1-10	10.01.06.03710
SPB1	15	Cup insert PA	SPI 12 PA SPB1-15	10.01.06.03709
SPB1	20	Cup insert PA	SPI 18 PA SPB1-20	10.01.06.03385
SPB1	25	Cup insert PA	SPI 22 PA SPB1-25	10.01.06.03315
SPB1	30	Cup insert PA	SPI 26 PA SPB1-30	10.01.06.03386
SPB1	40	Cup insert PA	SPI 33 PA SPB1-40	10.01.06.03387
SPB1	50	Cup insert PA	SPI 40 PA SPB1-50	10.01.06.03388
SPB1	60	-	-	-
SPB1	80	-	-	-

Type	Accessories			Part no.
SPB1	10	-	-	-
SPB1	15	-	-	-
SPB1	20	Sieve, round	SIEB 11x1 MS-A2 280 0.28/0.16	10.07.01.00309
SPB1	25	Sieve, round	SIEB 11x1 MS-A2 280 0.28/0.16	10.07.01.00309
SPB1	30	Sieve, round	SIEB 11x1 MS-A2 280 0.28/0.16	10.07.01.00309
SPB1	40	Sieve, round	SIEB 17.5x0.8 MS-A2 280 0.28/0.16	10.07.01.00308
SPB1	50	Sieve, round	SIEB 17.5x0.8 MS-A2 280 0.28/0.16	10.07.01.00308
SPB1	60	Sieve, round	SIEB 17.5x0.8 MS-A2 280 0.28/0.16	10.07.01.00308
SPB1	80	Sieve, round	SIEB 32.5x0.8 MS-A2 280 0.28/0.16	10.07.01.00364

Technical data Bellows Suction Cups SPB1 (1.5 Folds)

Type		Suction force (-600 mbar) [N]*	Pull-off force [N]	Lateral force [N]	Volume [cm ³]	Workpiece radius min. (convex) [mm]	Hose inner diameter (recom.) d [mm]**
SPB1	10	1.5	4.0	2.0	0.5	5	4
SPB1	15	4.3	9.0	5.0	1.5	8	4
SPB1	20	9.9	16.2	9.8	3.2	15	4
SPB1	25	14.9	23.4	13.0	5.3	20	4
SPB1	30	20.7	30.6	15.5	8.0	25	6
SPB1	40	35.9	46.8	24.8	18.4	40	6
SPB1	50	54.7	72.7	31.2	30.2	40	6
SPB1	60	78.0	100.9	49.4	49.3	70	6
SPB1	80	166.0	200.0	59.0	98.4	70	6

*The specified suction forces are theoretical values at a vacuum of -0.6 bar and with a smooth, dry workpiece surface - they do not include a safety factor

**The recommended hose diameter is based on a hose length of approx. 2 m

Bellows Suction Cups SPB1 (1.5 Folds)

Suction area (\emptyset) from 10 mm to 80 mm

Design data Bellows Suction Cups SPB1 (1.5 Folds)

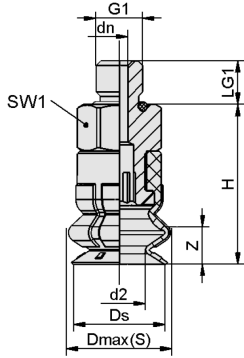

SPB1 10 - 15 AG

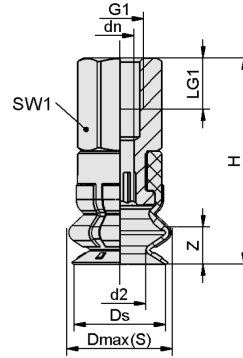

SPB1 10 - 15 IG

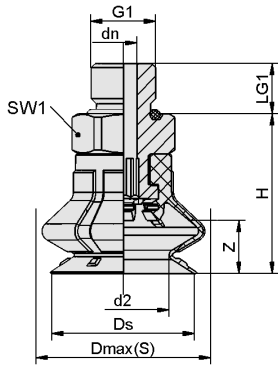

SPB1 20 - 80 AG

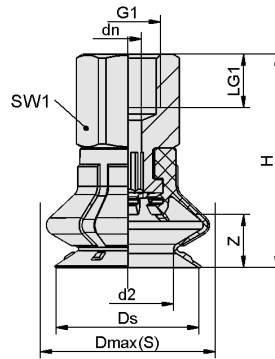

SPB1 20 - 80 IG

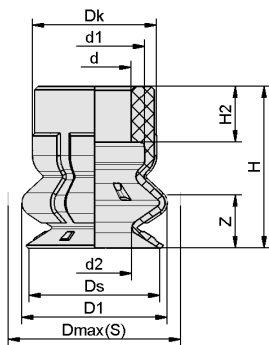

SPB1 10 - 15

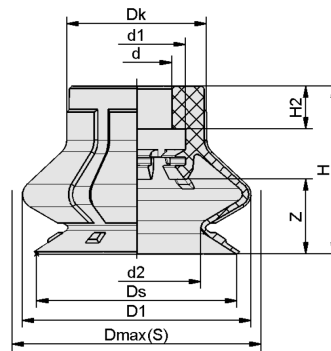

SPB1 20 - 80

Bellows Suction Cups SPB1 (1.5 Folds)

Suction area (\emptyset) from 10 mm to 80 mm

Design data Bellows Suction Cups SPB1 (1.5 Folds)

Type*	dn [mm]	d2 [mm]	Dmax(S) [mm]**	Ds [mm]	G1	H [mm]	LG1 [mm]	SW1 [mm]	Z (Stroke) [mm]
SPB1 10 ED-65 M5-AG	1.8	5.6	11.3	9.8	M5-M	18	4.7	8	4
SPB1 10 ED-65 M5-IG	3.1	5.6	11.3	9.8	M5-F	23	5.5	8	4
SPB1 15 ED-65 G1/8-AG	4.1	9.5	19.7	15.4	G1/8"-M	21	7.5	14	6
SPB1 15 ED-65 G1/8-IG	4.1	9.5	19.7	15.4	G1/8"-F	29	8.0	14	6
SPB1 20 ED-65 G1/8-AG	4.1	13.8	26.3	21.4	G1/8"-M	24	7.5	14	8
SPB1 20 ED-65 G1/8-IG	4.1	13.8	26.3	21.4	G1/8"-F	32	8.0	14	8
SPB1 25 ED-65 G1/8-AG	4.1	16.9	31.3	26.4	G1/8"-M	27	7.5	14	11
SPB1 25 ED-65 G1/8-IG	4.1	16.9	31.3	26.4	G1/8"-F	35	8.0	14	11
SPB1 30 ED-65 G1/8-AG	4.1	20.0	36.7	31.4	G1/8"-M	29	7.5	14	13
SPB1 30 ED-65 G1/8-IG	4.1	20.0	36.7	31.4	G1/8"-F	37	8.0	14	13
SPB1 30 ED-65 G1/4-AG	4.1	20.0	36.7	31.4	G1/4"-M	29	10.0	17	13
SPB1 40 ED-65 G1/4-AG	6.1	26.1	48.0	41.4	G1/4"-M	38	10.0	17	16
SPB1 40 ED-65 G1/4-IG	6.1	26.1	48.0	41.4	G1/4"-F	48	12.0	17	16
SPB1 50 ED-65 G1/4-AG	6.1	32.3	58.4	51.4	G1/4"-M	40	10.0	17	18
SPB1 50 ED-65 G1/4-IG	6.1	32.3	58.4	51.4	G1/4"-F	50	12.0	17	18
SPB1 60 ED-65 G1/4-AG	6.1	38.6	69.6	61.4	G1/4"-M	44	10.0	17	22
SPB1 60 ED-65 G1/4-IG	6.1	38.6	69.6	61.4	G1/4"-F	54	12.0	17	22
SPB1 80 ED-65 G1/4-AG	6.1	56.0	88.0	81.4	G1/4"-M	54	10.0	22	24
SPB1 80 ED-65 G1/4-IG	6.1	56.0	88.0	81.4	G1/4"-F	64	12.0	22	24
SPB1 80 ED-65 G3/8-IG	6.1	56.0	88.0	81.4	G3/8"-F	64	10.0	22	24
SPB1 80 ED-65 G3/8-AG	6.1	56.0	88.0	81.4	G3/8"-M	54	10.0	22	24
SPB1 80 ED-65 G1/2-IG	8.9	56.0	88.0	81.4	G1/2"-F	68	16.0	27	24
SPB1 80 ED-65 G1/2-AG	6.1	56.0	88.0	81.4	G1/2"-M	56	14.0	27	24

*Acceptable dimensional tolerances for rubber parts concerning to DIN ISO 3302-1 E3

**External dimension of the suction cup when it is pressed against the workpiece by the vacuum

Type*	d [mm]	d1 [mm]	d2 [mm]	D1 [mm]	Dk [mm]	Dmax(S) [mm]**	Ds [mm]	H [mm]	H2 [mm]	Z (Stroke) [mm]	
SPB1	10	5.5	7.5	5.6	11.0	9.4	11.3	9.8	12.1	4.2	4.0
SPB1	15	7.5	10.5	9.5	18.4	15.1	19.7	15.4	15.0	4.6	6.0
SPB1	20	7.5	10.5	13.8	24.6	15.1	26.3	21.4	18.0	4.6	8.0
SPB1	25	7.5	10.5	16.9	29.0	15.1	31.3	26.4	21.0	4.6	11.0

Bellows Suction Cups SPB1 (1.5 Folds)

Suction area (Ø) from 10 mm to 80 mm

Type*		d [mm]	d1 [mm]	d2 [mm]	D1 [mm]	Dk [mm]	Dmax(S) [mm]**	Ds [mm]	H [mm]	H2 [mm]	Z (Stroke) [mm]
SPB1	30	7.5	10.5	20.0	34.2	15.1	36.7	31.4	23.0	4.6	13.0
SPB1	40	11.0	17.5	26.1	44.6	21.6	48.0	41.4	30.0	7.0	16.0
SPB1	50	11.0	17.5	32.3	55.2	21.6	58.4	51.4	32.0	7.0	18.0
SPB1	60	11.0	17.5	38.6	65.7	21.6	69.6	61.4	36.0	7.0	22.0
SPB1	80	14.0	29.3	56.0	82.7	27.1	88.0	81.4	45.9	15.3	23.5

*Acceptable dimensional tolerances for rubber parts concerning to DIN ISO 3302-1 E3

**External dimension of the suction cup when it is pressed against the workpiece by the vacuum